



*Meubles de Qualité à prix Abordable
Affordable Quality Home Furniture*

**TABLE À GOUTER 2MCX BRUN MARTELÉ /DESSUS
TUILE TERRACOTTA**

**TERRACOTTA TILE TOP / HAMMERED BROWN 2PCS
NESTING TABLES**

I 3161

**INSTRUCTIONS D'ASSEMBLAGE
ASSEMBLY INSTRUCTIONS**

MONARCH SPECIALTIES INC.









**POUR DE L'ASSISTANCE OU POUR COMMANDER
DES PIÈCES CONTACTEZ NOTRE DÉPARTEMENT
DE SERVICE À LA CLIENTÈLE.**

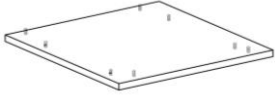
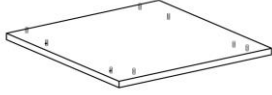
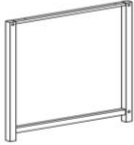

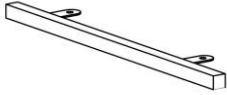

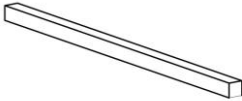

**FOR ASSISTANCE OR TO ORDER PARTS
CONTACT OUR CUSTOMER SERVICE DEPARTMENT**

WWW.MONARCHSERVICE.COM

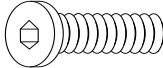
IDENTIFICATION DES PIÈCES
PARTS IDENTIFICATION

A		DESSUS DE TABLE (GRANDE) LARGE TABLE TOP	1MC 1PC
B		DESSUS DE TABLE (PETIT) SMALL TABLE TOP	1MC 1PC
C		CADRE DU CÔTÉ (GRANDE) LARGE SIDE FRAME	2MCX 2PCS
D		CADRE DU CÔTÉ (PETIT) SMALL SIDE FRAME	2MCX 2PCS
E		GRANDE BARRE TRANSVERSALE LARGE CROSS BAR	2MCX 2PCS
F		PETITE BARRE TRANSVERSALE SMALL CROSS BAR	2MCX 2PCS
G		BARRE TRANSVERSALE DE BASE (GRANDE) LARGE CROSS BAR BASE	2MCX 2PCS
H		BARRE TRANSVERSALE DE BASE (PETIT) SMALL CROSS BAR BASE	2MCX 2PCS

IDENTIFICATION DES PIÈCES DE MONTAGE
HARDWARE IDENTIFICATION

I		M6X45MM M6X35MM	6MCX / 6PCS 6MCX / 6PCS
J		M8	16MCX/ 16PCS
K		DIAMETER 22MM	6MCX / 6PCS
L		M8 M6	4MCX / 4PCS 4MCX / 4PCS
M		M6	1MC / 1PC
N		M8	1MC / 1PC

ÉTAPE / STEP 1

**NE SERRER PAS LES VIS AVANT DE TERMINER L'ASSEMBLAGE.
DO NOT TIGHTEN SCREWS UNTIL COMPLETELY ASSEMBLY.**

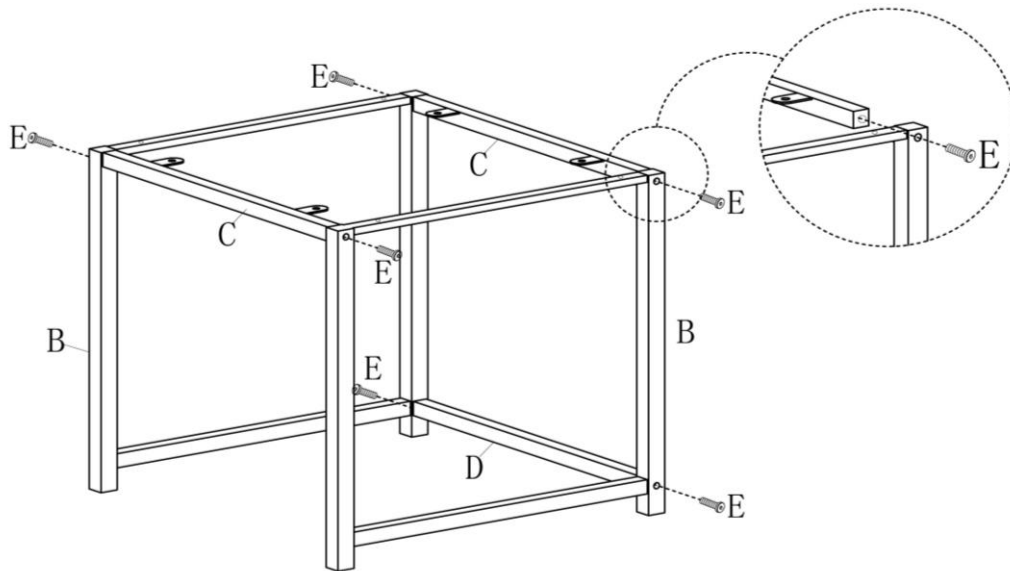

ÉTAPE / STEP 2

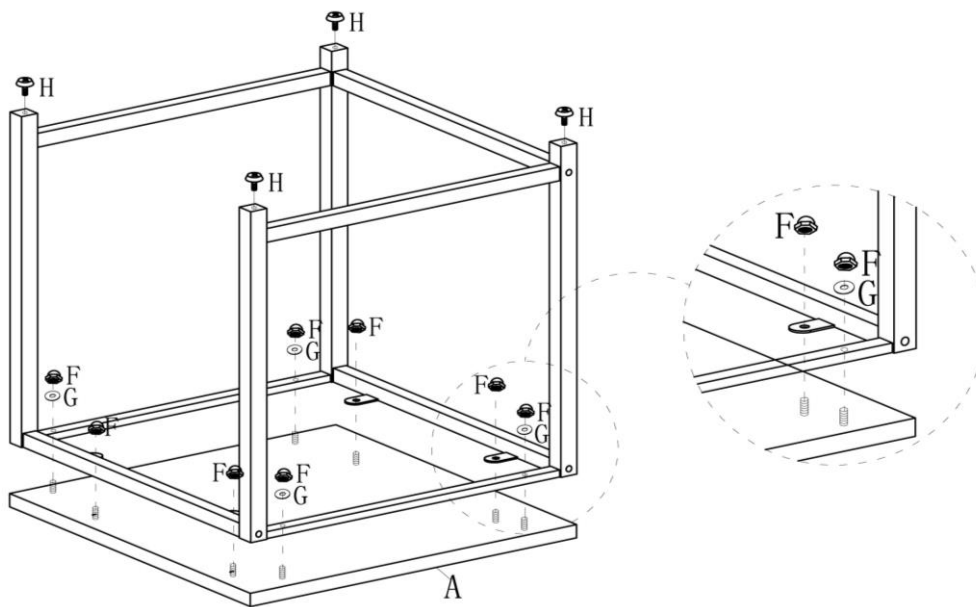

ÉTAPE / STEP 3

